

Artemide®

Nessino

design

G. Mattioli

Gruppo Architetti Urbanisti Città Nuova

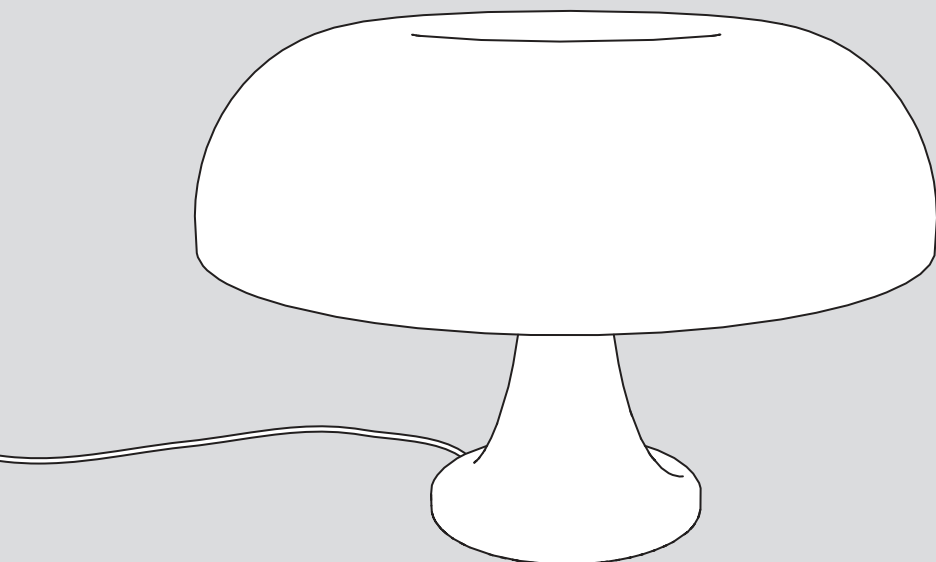



i

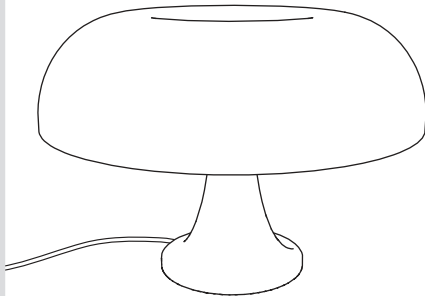
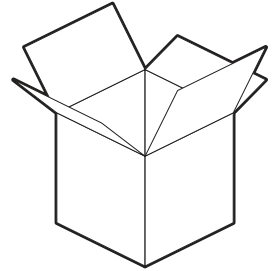
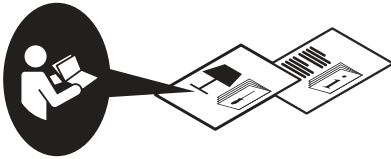
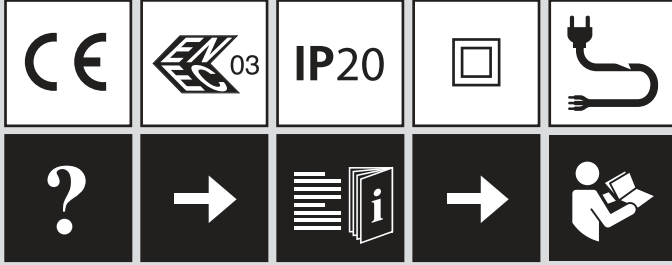

1

4 x Max 20W - E14

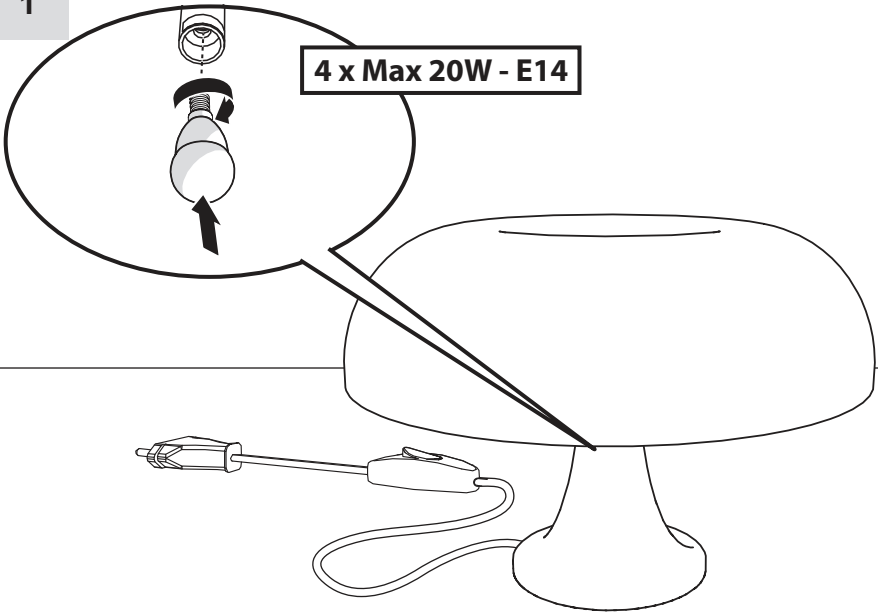

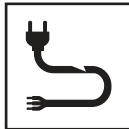
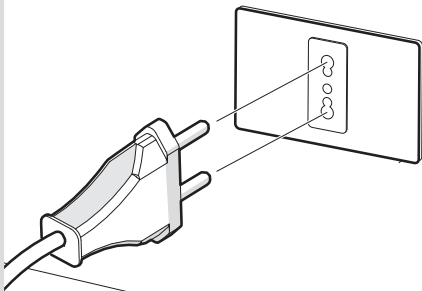

2

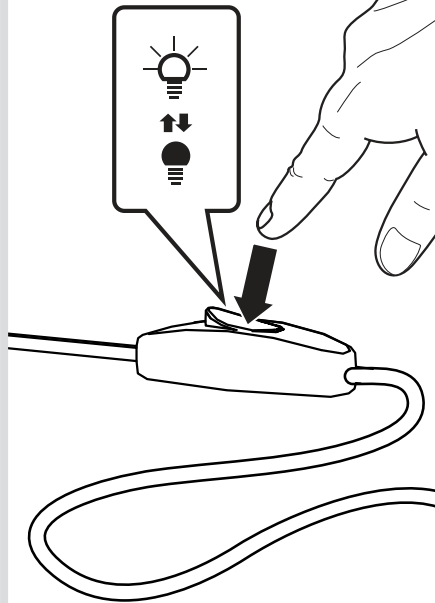

3

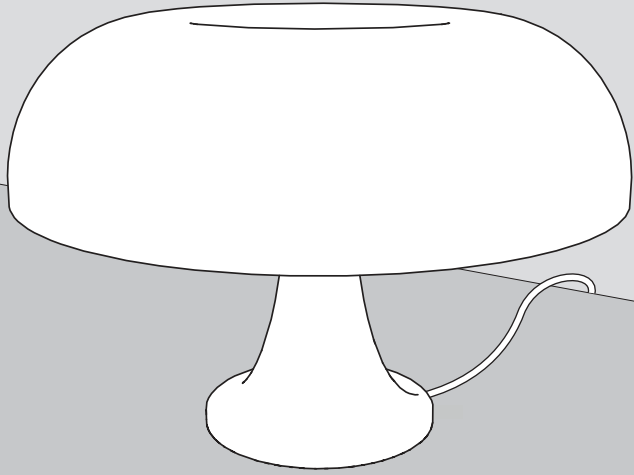





4 x Max 20W - E14

Halo: HSGSP - 250 lm

LED: DRBP - 250 lm

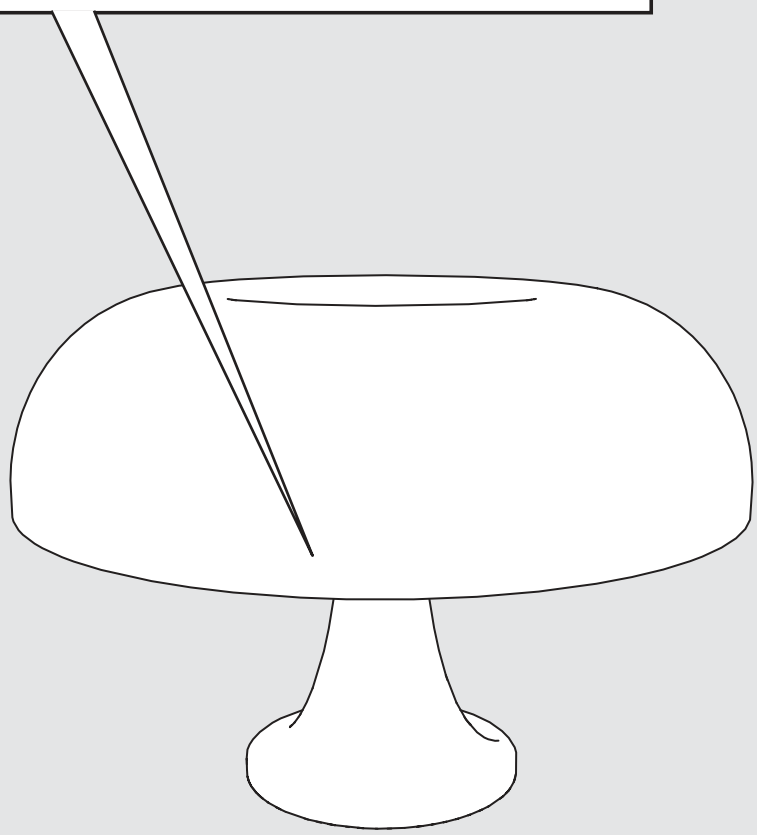

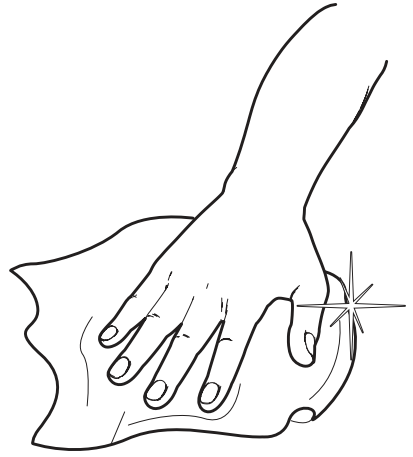
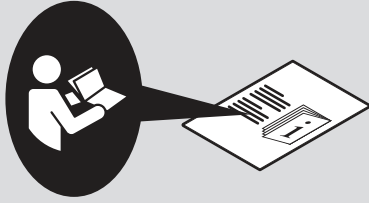

Artemide®

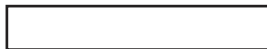

Artemide

via Bergamo, 18
20010 Pregnana M.se (MI)
ITALIA

tel. +39 02 935 181
fax +39 02 935 90 254
fax +39 02 935 90 496

www.artemide.com

VAT IT00846890150

cod. Y513000593