

GEBRAUCHSANLEITUNG

D

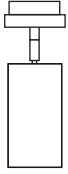

STAR SPOT 30-65° DLR

ART.-NO. 864070

TECHNISCHE DATEN

Spannung: 230V~
Leistung: 10W
Farbtemperatur: 2.700K

Schutzklasse:

Dimmbar:
bruck.de/de/faq/bruck



ALLGEMEINE SICHERHEITSHINWEISE



1. Bei allen durchzuführenden Arbeiten an den Produkten (Montage, Wartung, Reinigung) Spannungsversorgung abschalten.
2. Die Produkte sind nur für IP 20 Bereiche zugelassen.
3. Vorsicht! Produkte (auch LED) können im Betrieb heiß werden.
4. Den angegebenen Mindestabstand der Lichtquelle zu brennbaren Gegenständen beachten*
5. Wir behalten uns vor, jederzeit Änderungen an den Produkten vorzunehmen! Aktuelle Daten finden sie jederzeit unter www.bruck.de.
6. Bei eigenmächtigen Veränderungen oder unsachgemäßer Benutzung erlischt jeglicher Anspruch auf Gewährleistung.



LIEFERUMFANG
1 LEUCHE KOMPLETT

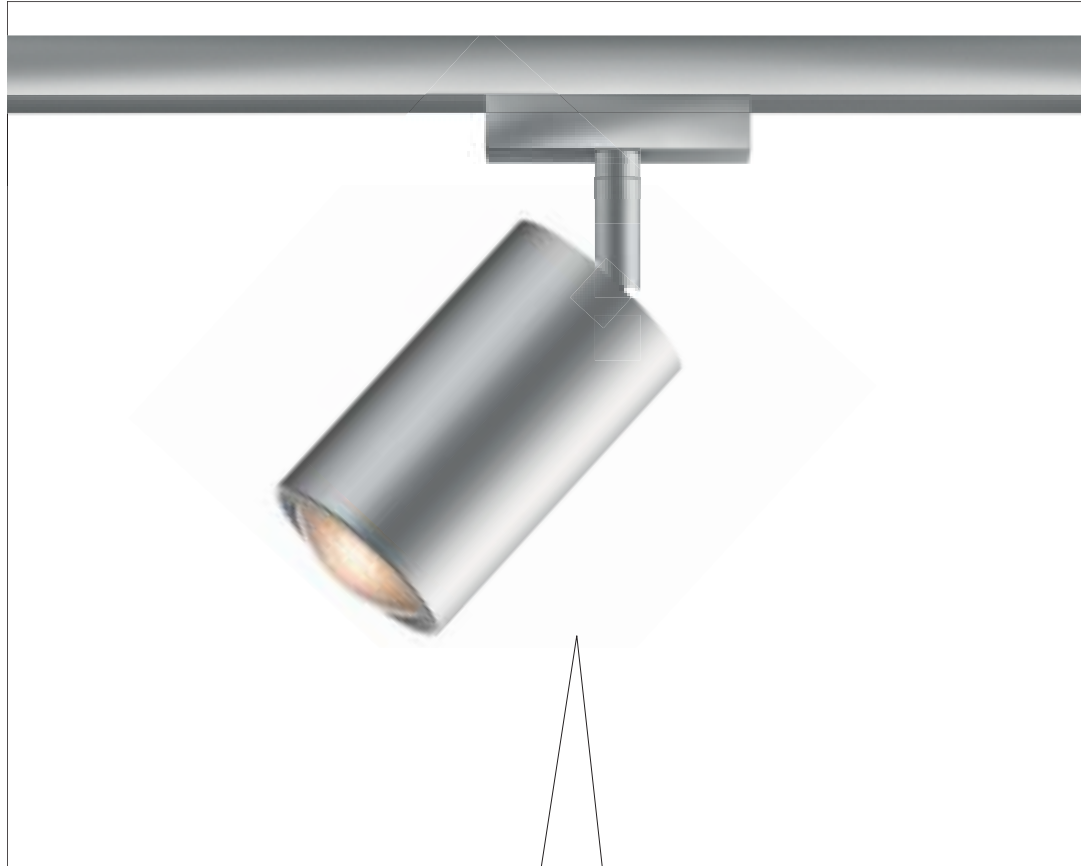

MONTAGE: FALSCH

MOUNTING: WRONG
MONTAGE: INCORRECT
MONTAJE: INCORRECTO
MONTAGGIO: SBAGLIATO

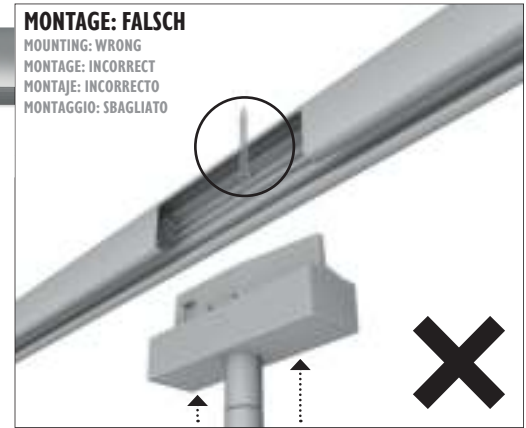

MONTAGE: RICHTIG

MOUNTING: CORRECT
MONTAGE : CORRECT
MONTAJE: CORRECTO
MONTAGGIO: CORRETTO

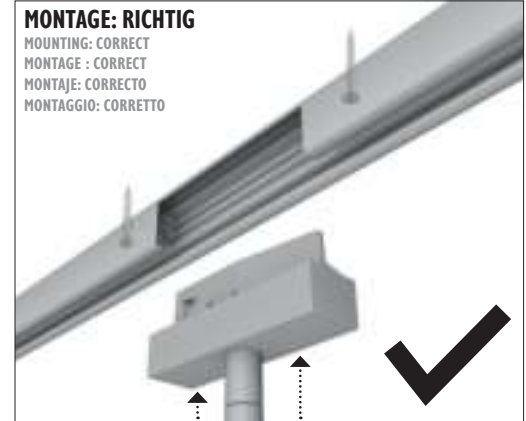

Zoom 30°min - 65° max

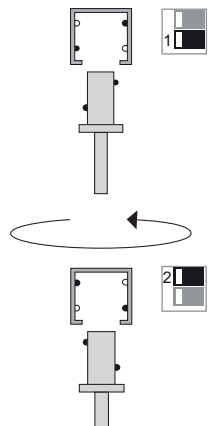
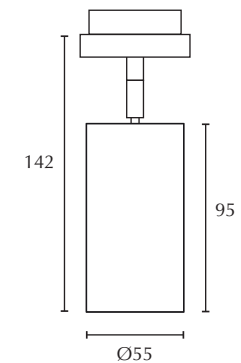
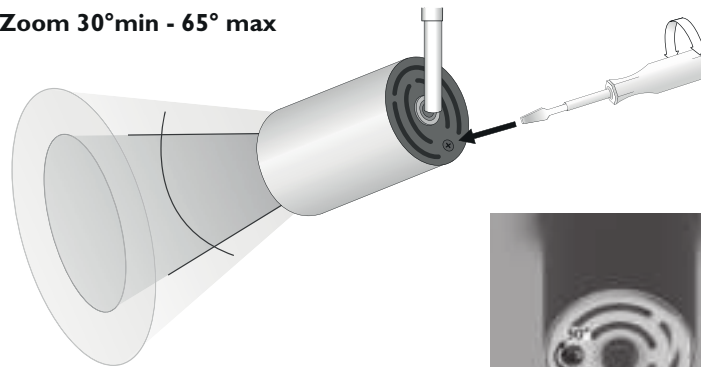



INSTRUCTION MANUAL

GB

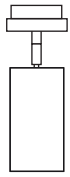

STAR SPOT 30-65° DLR

ART.-NO. 864070

TECHNICAL DATA

Voltage: 230V~
 Wattage: 10W
 Colour temperature: 2.700K

Protection class:

Dimmable:
bruck.co.uk/en/faq/dimmer-recommendation/



GENERAL REMARKS ON SAFETY



1. For all work to be carried out on the products (assembly, maintenance, repair, cleaning, etc.) switch off the power supply.
2. The products are only approved for IP 20 areas.
3. Caution! Products (also LED) can become hot during operation.
4. Observe the specified minimum distance of the light source to flammable objects *
5. We reserve the right to make changes to the products at any time! Current data can be found at www.bruck.co.uk.
6. With arbitrary changes or improper use any warranty claim expires.



DELIVERY SCOPE:
 1 LUMINAIRE COMPLETE



MODE D'EMPLOI

F

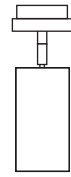

STAR SPOT 30-65° DLR

REF. 864070

CARACTERISTIQUES TECHNIQUES

Voltage: 230V~
 Puissance: 10W
 Température de couleur: 2.700K

Classe de protection:

Gradable:
bruckclairage.fr/fr/faq/recommandation-du-gradateur/



CONSIGNES DE SECURITE GENERALES



1. Pour tous les travaux à effectuer sur les produits (montage, entretien, réparation, nettoyage, etc.) il faut couper l'alimentation électrique.
2. Les produits ne sont homologués que pour les zones IP 20.
3. Attention! Les produits (également LED) peuvent devenir chauds pendant le fonctionnement.
4. Respecter la distance minimale spécifiée entre la source lumineuse et les objets inflammables *
5. Nous nous réservons le droit d'apporter des modifications aux produits à tout moment ! Les données actuelles peuvent être consultées à tout moment sur www.bruckclairage.fr.
6. En cas de modifications arbitraires ou d'utilisation incorrecte, la garantie expire.



VOLUME DE LIVRAISON:
 1 LUMINAIRE COMPLÈTE



INSTRUCCIONES DE EMPLEO

E

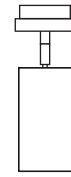

STAR SPOT 30-65° DLR

REF. 864070

DATOS TECNICOS

Voltaje: 230V~
 Potencia: 10W
 Temperatura de color: 2.700K

Clase de protección:

Regulable:
bruck.com.es/es/faq/recomendacion-de-atenuacion/



INDICACIONES GENERALES DE SEGURIDAD



1. Para todos los trabajos a realizar en los productos (montaje, mantenimiento, reparación, limpieza, etc.) hay que desconectar la alimentación eléctrica.
2. Los productos sólo están aprobados para áreas IP 20.
3. Precaución! Los productos (también LED) pueden calentarse durante el funcionamiento.
4. Observar la distancia mínima especificada entre la fuente de luz y los objetos inflamables *
5. Nos reservamos el derecho de hacer cambios en los productos en cualquier momento! Los datos actuales se pueden encontrar en www.bruck.com.es.
6. Con cambios arbitrarios o uso indebido caduca cualquier reclamo de garantía.



VOLUMEN DE ENTREGA:
 1 LAMPARA COMPLETA



ISTRUZIONI PER L'USO

I

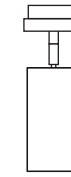

STAR SPOT 30-65° DLR

COD. 864070

DATI TECNICI

Tensione: 230V~
 Wattaggio: 10W
 Temperatura colore: 2.700K

Tipo di protezione:

Dimmerabile:
bruck.co.it/it/faq/raccomandazione-varialuce/



AVVERTENZE GENERALI PER LA SICUREZZA



1. Per tutti i lavori da eseguire sui prodotti (montaggio, manutenzione, riparazione, pulizia ecc.) spegnere l'alimentazione elettrica.
2. I prodotti sono approvati solo per ambienti IP 20.
3. Attenzione! I prodotti (anche i LED) possono riscaldarsi in funzione.
4. Rispettare la distanza minima specificata della sorgente luminosa dagli oggetti che sono infiammabili *
5. Ci riserviamo il diritto di apportare modifiche ai prodotti in qualsiasi momento! I dati attuali possono essere trovati in qualsiasi momento all'indirizzo www.bruck.co.it.
6. In caso di modifiche non autorizzate o di uso improprio, tutti i diritti di garanzia scadano.



VOLUME DELLA FORNITURA:
 1 LAMPADA COMPLETA



ADAPTER MONTIEREN / ASSEMBLING THE ADAPTER THE ADAPTER / MONTAGE DE L'ADAPTATEUR / MONTAJE DEL ADAPTADOR / MONTARE L'ADATTATORE

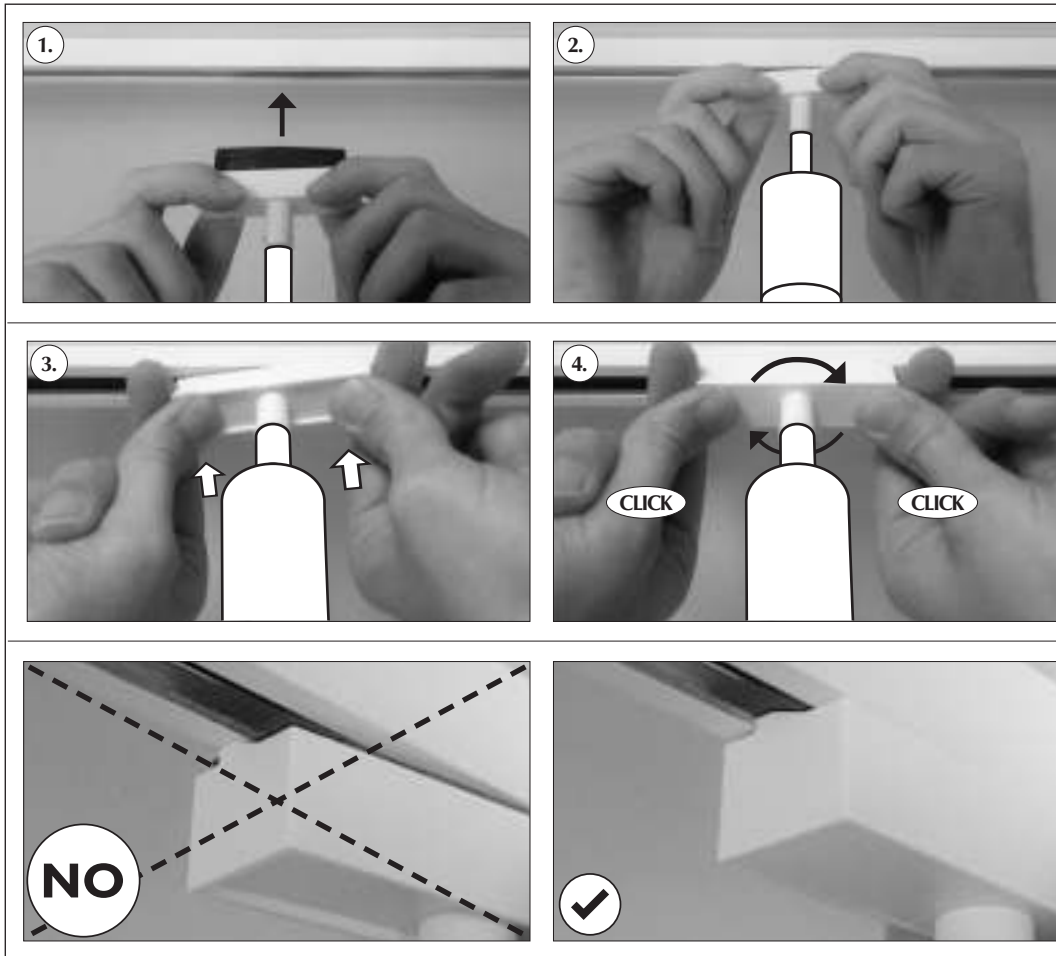

ADAPTER ABMONTIEREN / DISASSEMBLING THE ADAPTER / DEMONTAGE DE L'ADAPTATEUR / DESMONTAJE DEL ADAPTADOR / RIMUOVERE L'ADATTATORE

